

BC 250 12/24 BY-PASS



PURCHASE CODES

BC 250 12/24V without thermo switch	3RBC25012BP 3RBC25024BP
BC 250 12/24V with thermo switch	3RBC25012T247BP 3RBC25012T260BP 3RBC25024T247BP 3RBC25024T260BP

SPARE PARTS

Cooling element	1RO03379BP
Frame	3CNL300.1
Electric fan 12V	1VNAPL30012C
Electric fan 24V	1VNAPL30024C
Thermo-switch 47-36 12V IP 67	1TRM 47-36/12V
Thermo-switch 47-36 24V IP 67	1TRM 47-36/24V
Thermo-switch 60-49 12V IP 67	1TRM 60-49/12V
Thermo-switch 60-49 24V IP 67	1TRM 60-49/24V
By-pass	9FTBC

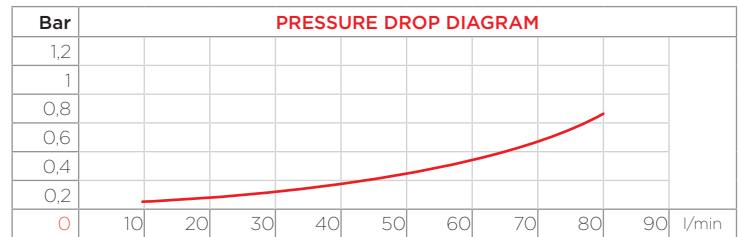
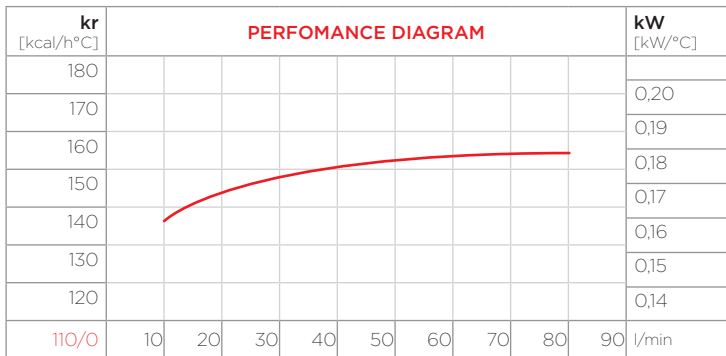

CORRECTION FACTOR

cSt	22	30	46	68	100	150	220
f	0,6	1	1,5	2,3	3,5	5	7

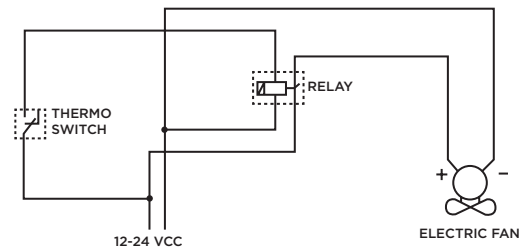

- Dimensions and technical characteristics are not binding

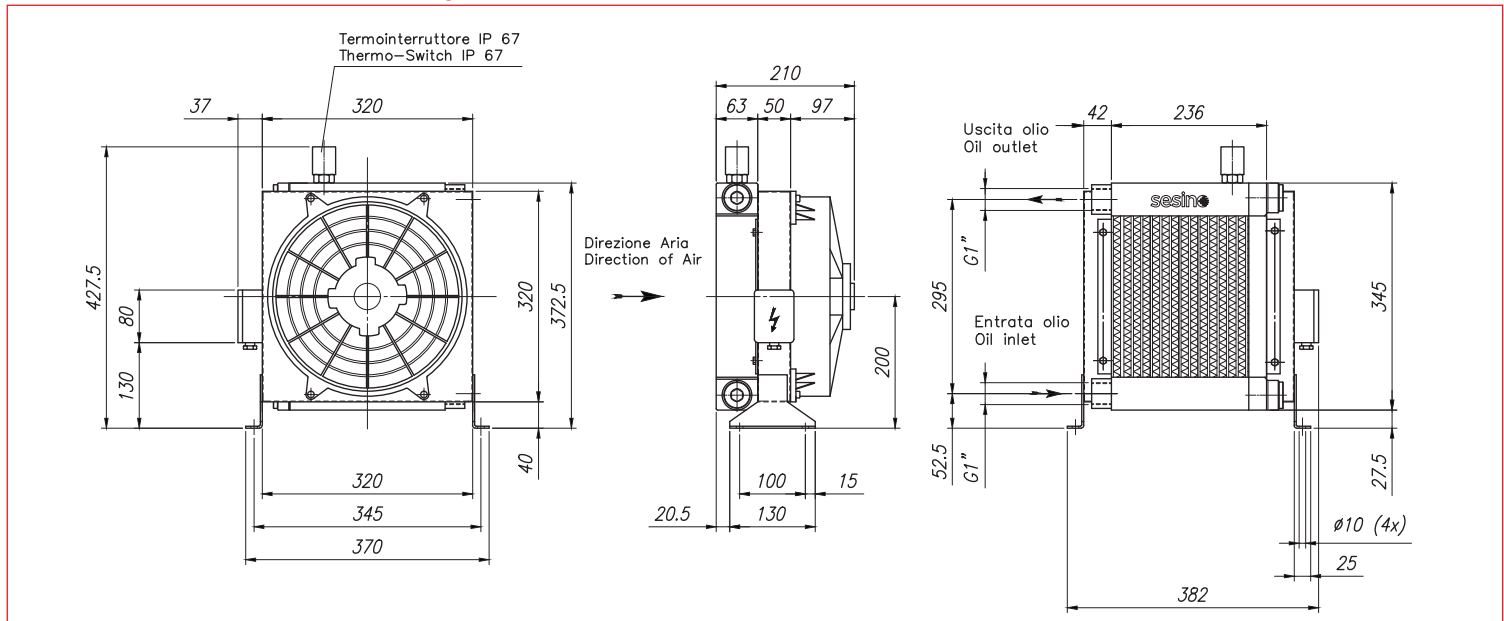

OIL FLOW	VOLTAGE	POWER	CURRENT	AIR FLOW	ELECTRIC PROTECTION	NOISE LEVEL	WEIGHT	Ø FAN
l/min	V	W	A	m³/h	IP	dB(A)	kg	mm
20-150	12	190	14,8	1.700	68	79	10	280
20-150	24	190	7,4	1.700	68	79	10	280