

AP 830 EMX

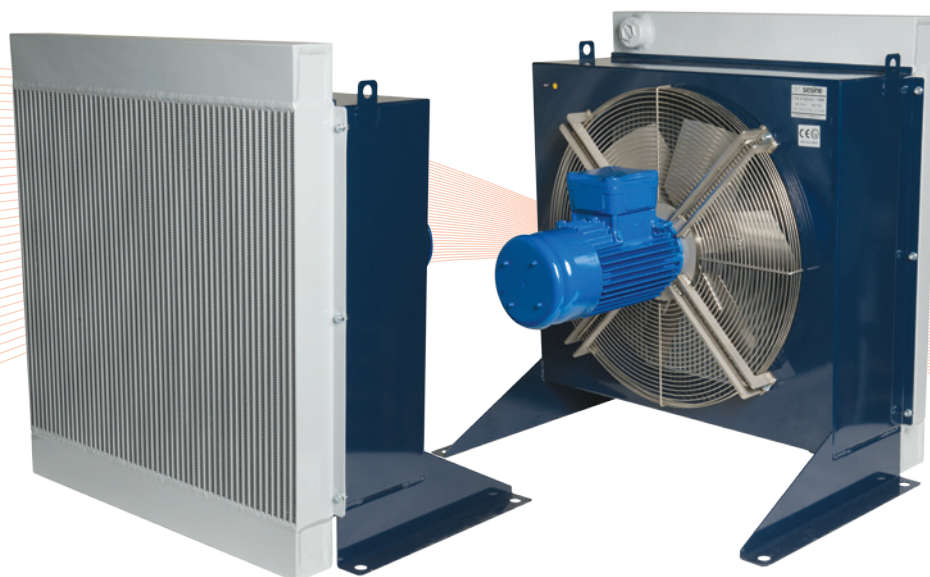
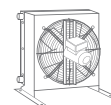

PURCHASE CODES

AP 830 EMX three-phase 400V 50HZ	3RAP830EMX50
AP 830 EMX three-phase 460V 60HZ	3RAP830EMX60

SPARE PARTS

Cooling element	3RNL830A
Frame	3CNAP830EMX.1
Electric fan 400V 50Hz	1VNAP830EMX50
Electric fan 460V 60Hz	1VNAP830EMX60

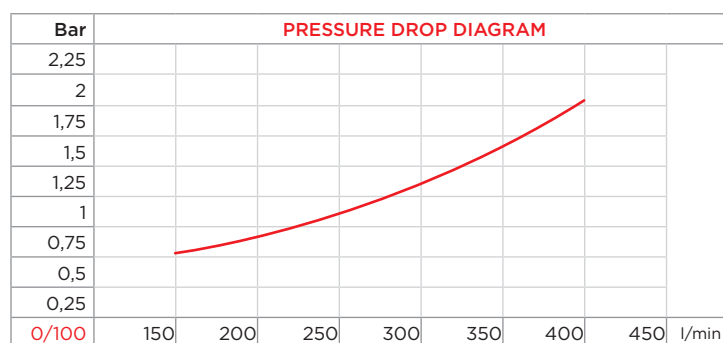
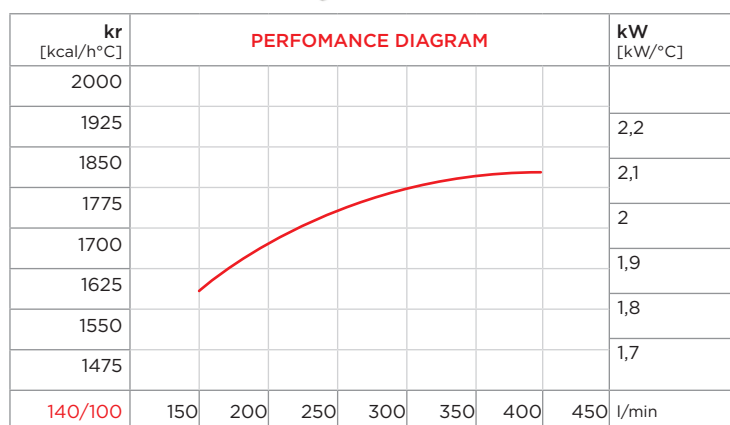

CORRECTION FACTOR

cSt	22	30	46	68	100	150	220
f	0,6	1	1,5	2,3	3,5	5	7

- Dimensions and technical characteristics are not binding

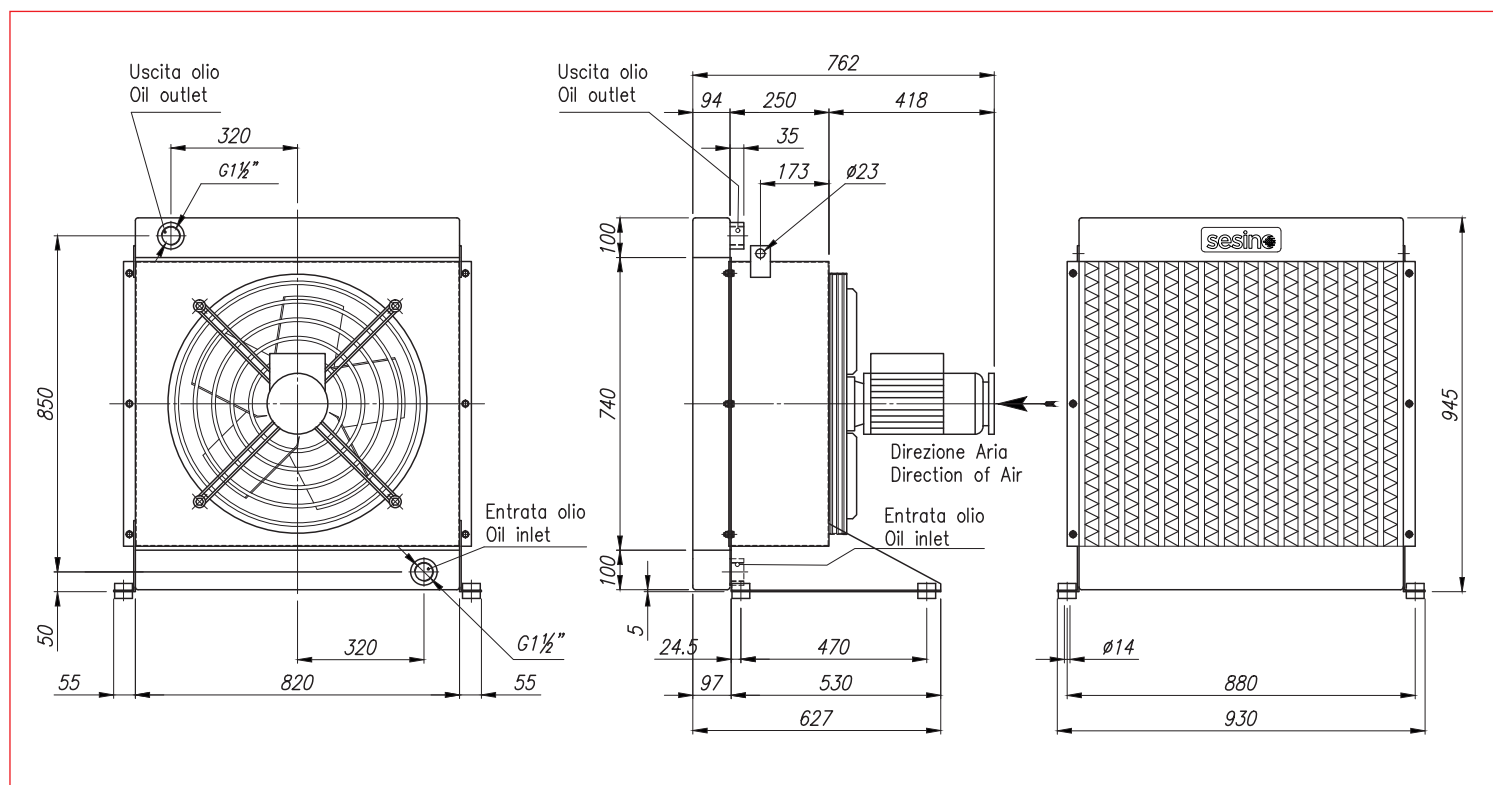

CODE	OIL FLOW l/min	CAPACITY l	VOLT. V	FREQ. Hz	POWER W	CURRENT A	AIR FLOW m³/h	PROTECTION IP	NOISE LEV. dB(A)	WEIGHT kg	Ø FAN mm	TEMP. °C
3RAP830EMX50	150-400	20	400	50	1100	2,58	10000	56	87	115	560	-20/+40
3RAP830EMX60	150-400	20	460	60	1100	2,24	10600	56	87	115	560	-20/+40