

AP 680 EMX

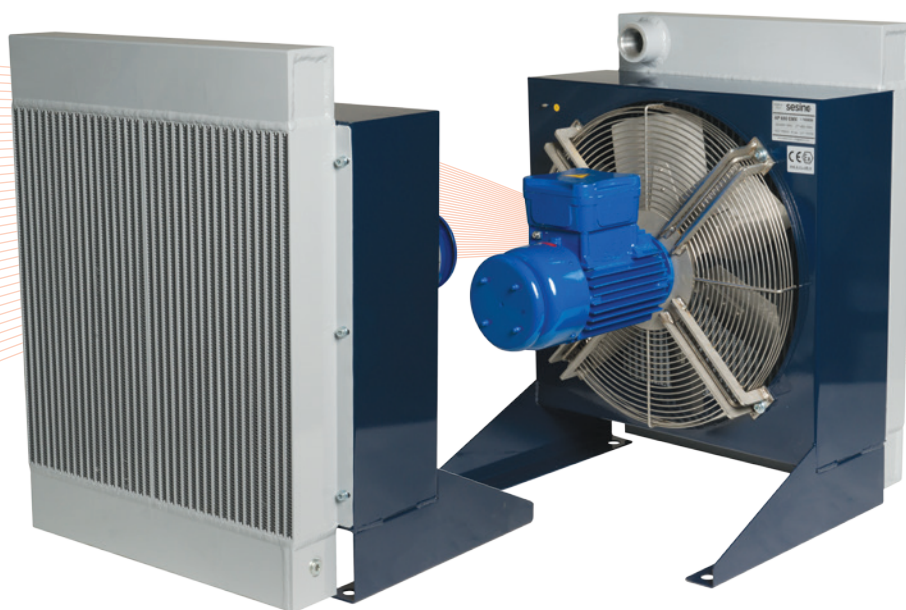
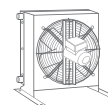

PURCHASE CODES

AP 680 EMX three-phase 400V 50Hz	3RAP680EMX50
AP 680 EMX three-phase 460V 60Hz	3RAP680EMX60

SPARE PARTS

Cooling element	3RNL680A
Frame	3CNAP680EMX.1
Electric fan 400V 50Hz	1VNAP680EMX50
Electric fan 460V 60Hz	1VNAP680EMX60

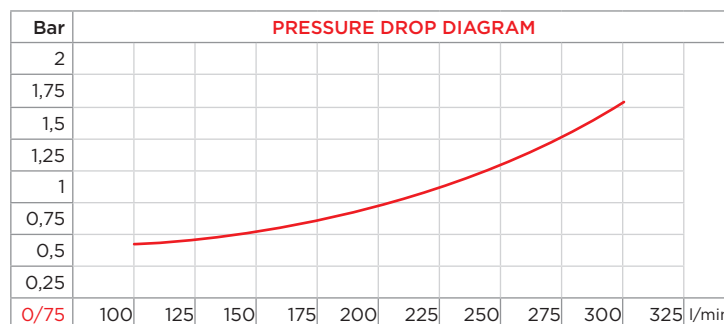
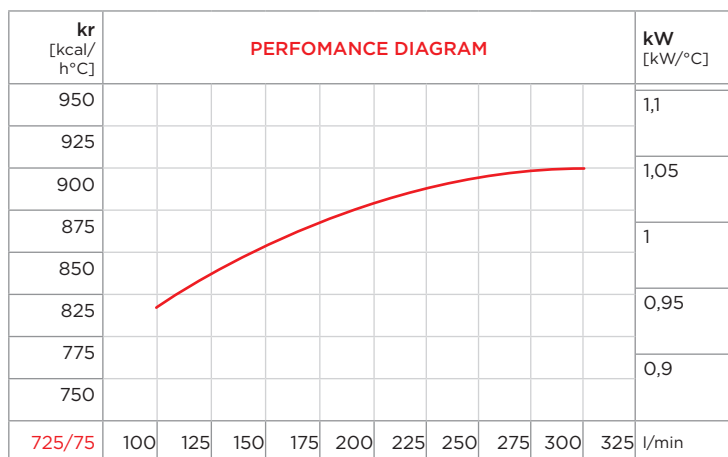

CORRECTION FACTOR

cSt	22	30	46	68	100	150	220
f	0,6	1	1,5	2,3	3,5	5	7

- Dimensions and technical characteristics are not binding

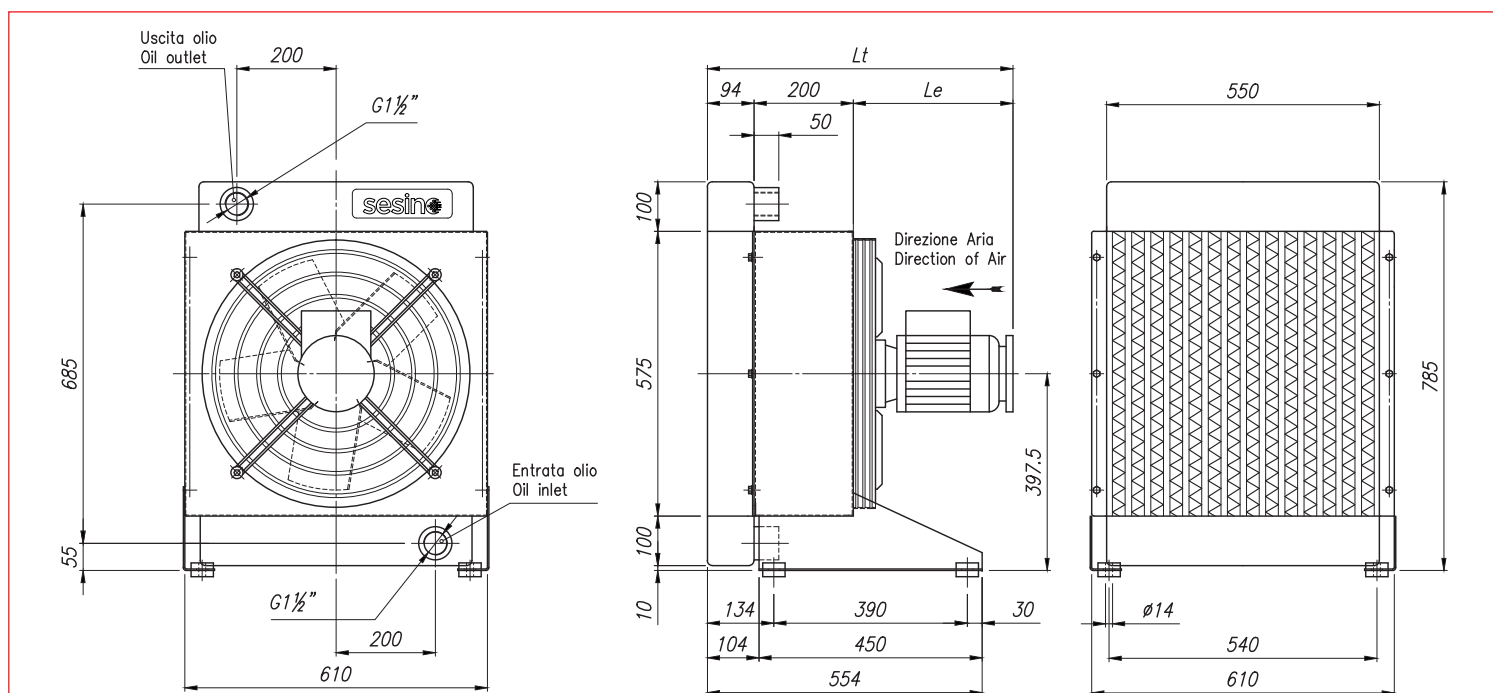

CODE	OIL FLOW l/min	CAPACITY l	VOLT. V	FREQ. Hz	POWER W	CURRENT A	AIR FLOW m³/h	PROTECTION IP	NOISE LEV. dB(A)	WEIGHT kg	ø FAN mm	TEMP. °C	DIMENSION	
													Le	Lt
3RAP680EMX50	100-300	15	400	50	550	1,6	7500	56	86	89	500	-20/+40	322	616
3RAP680EMX60	100-300	15	460	60	750	1,79	7900	56	86	89	500	-20/+40	364	658